

Spare parts

F1-90°/45° APS Plasma-Spray Gun

Spare Parts List

01

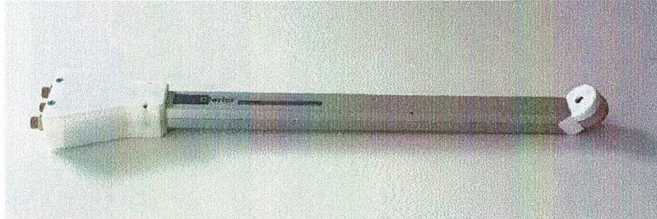

02

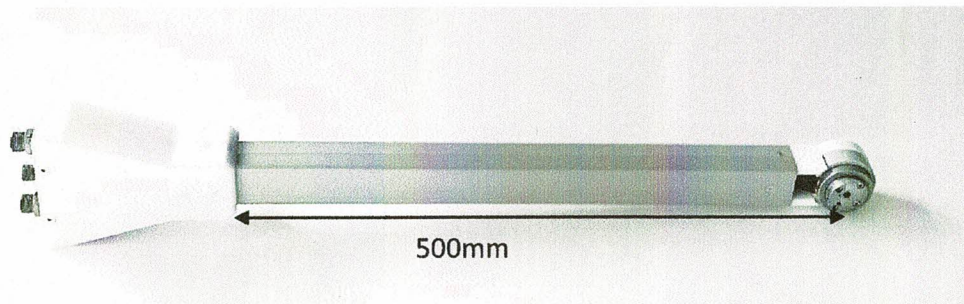
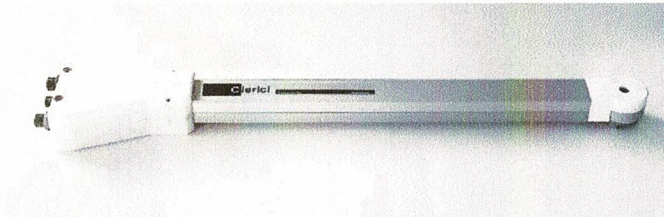

Position	Description	Art.-No.
01	F1-45° Burner 500mm, complete	CE-001815
01	F1-45° Burner 600mm, complete	CE-001826
02	F1-90° Burner 500mm, complete	CE-001814
02	F1-90° Burner 600mm, complete	CE-001827

Spare Parts List

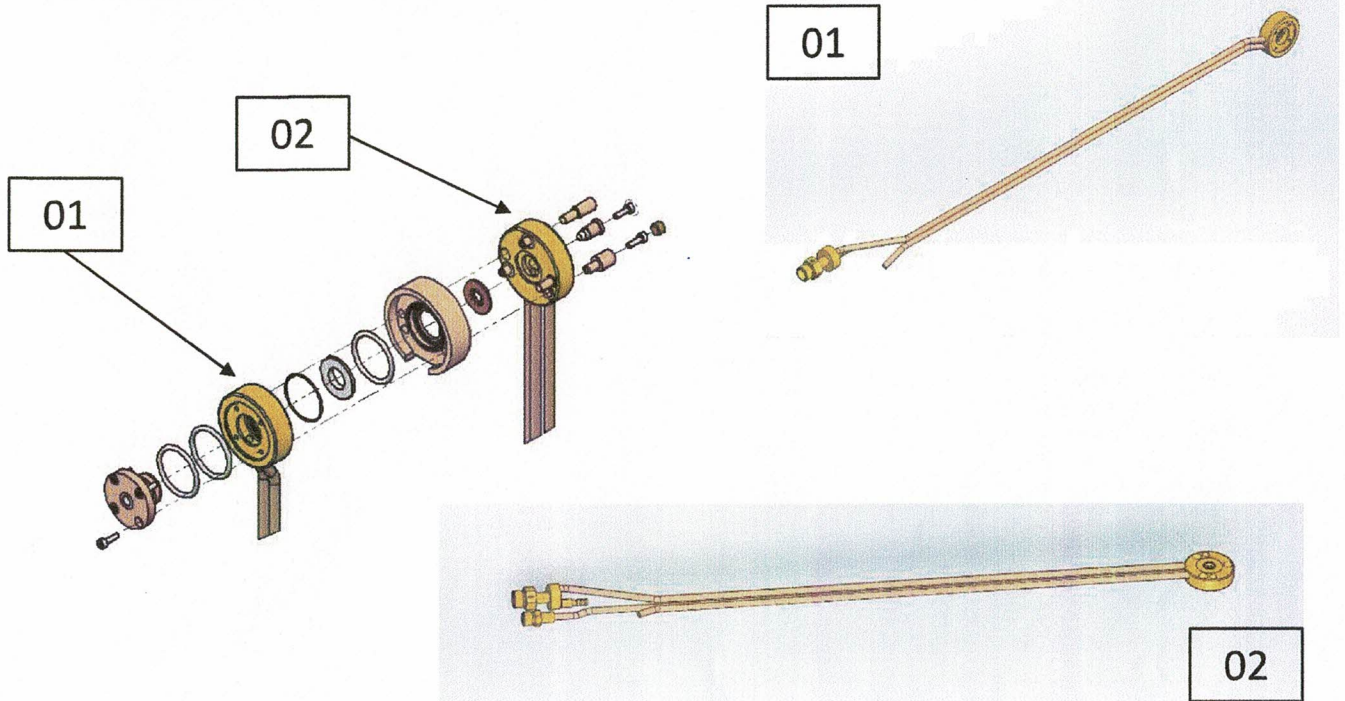

Position	Description	Art.-No.	Quantity 90°	Quantity 45°
01	Front body F1-90°, 500mm, complete	CE-001347	1	
01	Front body F1-90°, 600mm, complete	CE-001837	(1)	
01	Front body F1-90°, 700mm, complete	CE-001838	(1)	
01	Front body F1-90°, 750mm, complete	CE-001839	(1)	
01	Front body F1-45°, 500mm, complete	CE-001373		1
01	Front body F1-45°, 600mm, complete	CE-001834		(1)
01	Front body F1-45°, 700mm, complete	CE-001835		(1)
01	Front body F1-45°, 750mm, complete	CE-001836		(1)
02	Rear body F1-90°, 500mm, complete	CE-001379	1	
02	Rear body F1-90°, 600mm, complete	CE-001828	(1)	
02	Rear body F1-90°, 700mm, complete	CE-001829	(1)	
02	Rear body F1-90°, 750mm, complete	CE-001830	(1)	
02	Rear body F1-45°, 500mm, complete	CE-001380		1
02	Rear body F1-45°, 600mm, complete	CE-001831		(1)
02	Rear body F1-45°, 700mm, complete	CE-001832		(1)
02	Rear body F1-45°, 750mm, complete	CE-001833		(1)

Spare Parts List

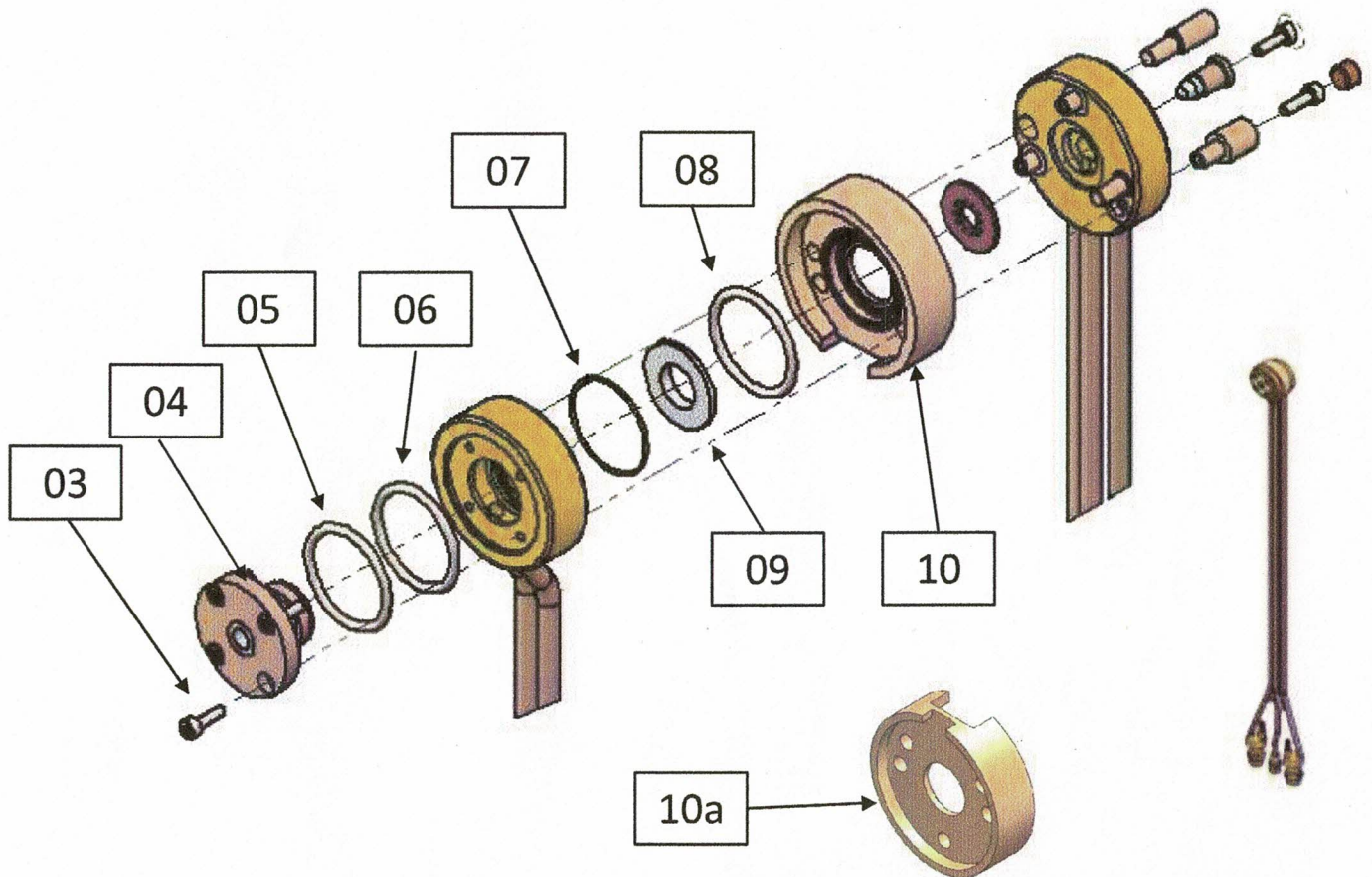

Position	Description	Art.-No.	Quantity 90°	Quantity 45°
03	Hex socket head cap screw M3x10 stainless steel	CE-001823	4	4
04	Nozzle D=6mm with O-Ring	CE-001749	1	1
05	O-Ring D=18.00x2.00 Viton	CE-001046	1	1
06	O-Ring D=19.00x1.50 Viton	CE-001045	1	1
07	O-Ring D=20.00x1.00 Viton	CE-001848	1	1
08	O-Ring D=27.00x1.00 NBR	CE-002216	2	2
09	Ceramic ring	CE-001375	1	1
10	Intermediate section F1 compl.	CE-001376	1	1
10a	Intermediate section	CE-002218	(1)	(1)

Spare Parts List

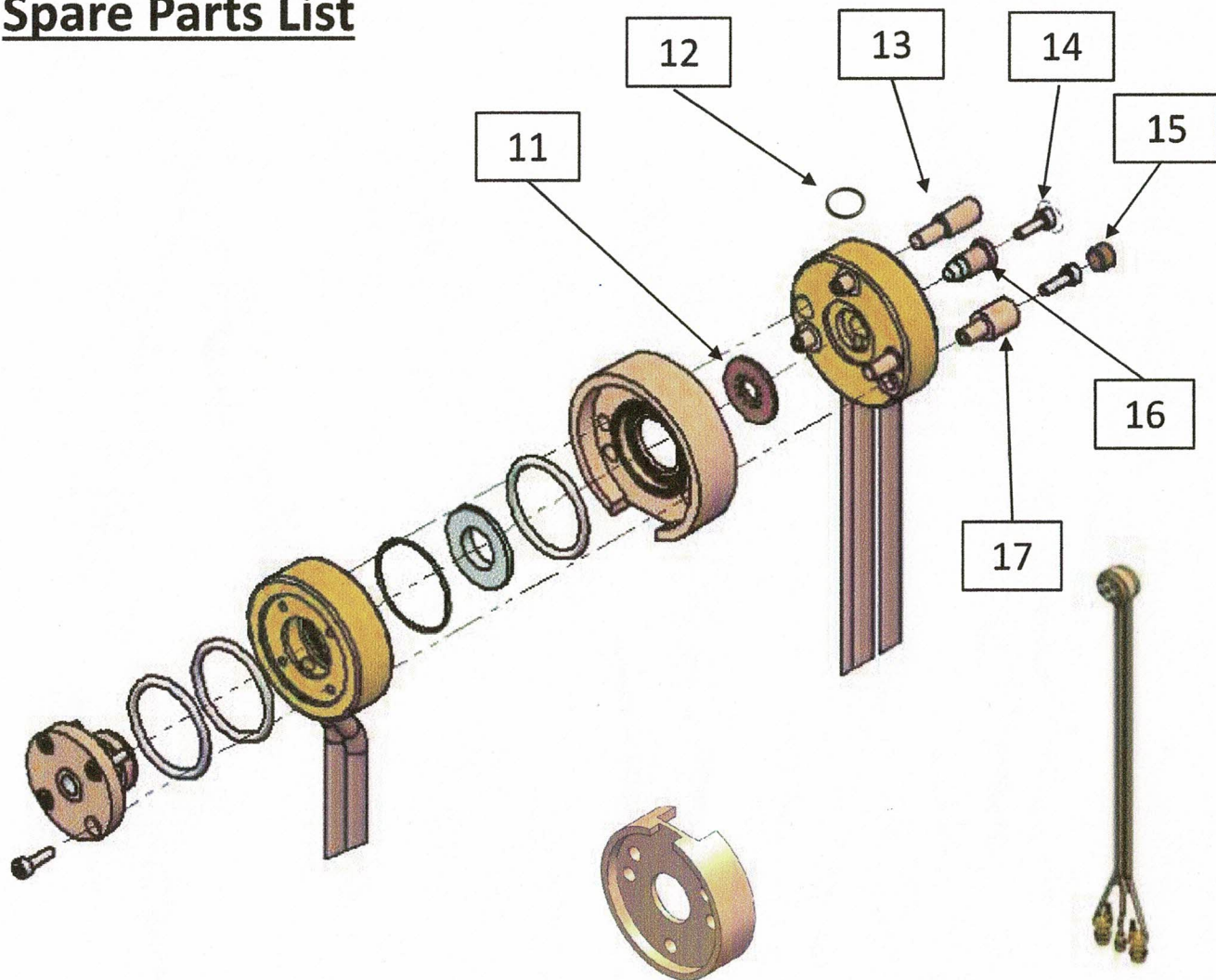

Position	Description	Art.-No.	Quantity 90°	Quantity 45°
11	Gas Distribution ring F1	CE-001377	1	1
12	O-Ring D=03.00x1.00 NBR	CE-002219	3	3
13	Centering bolt with O-Ring	CE-001381	2	2
14	Hex socket cap Screw M3x16	CE-001824	3	3
15	Insulating screw M7x1	CE-001809	3	3
16	Electrode F1	CE-001757	1	1
17	Insulating sleeve	CE-001382	3	3

Spare Parts List

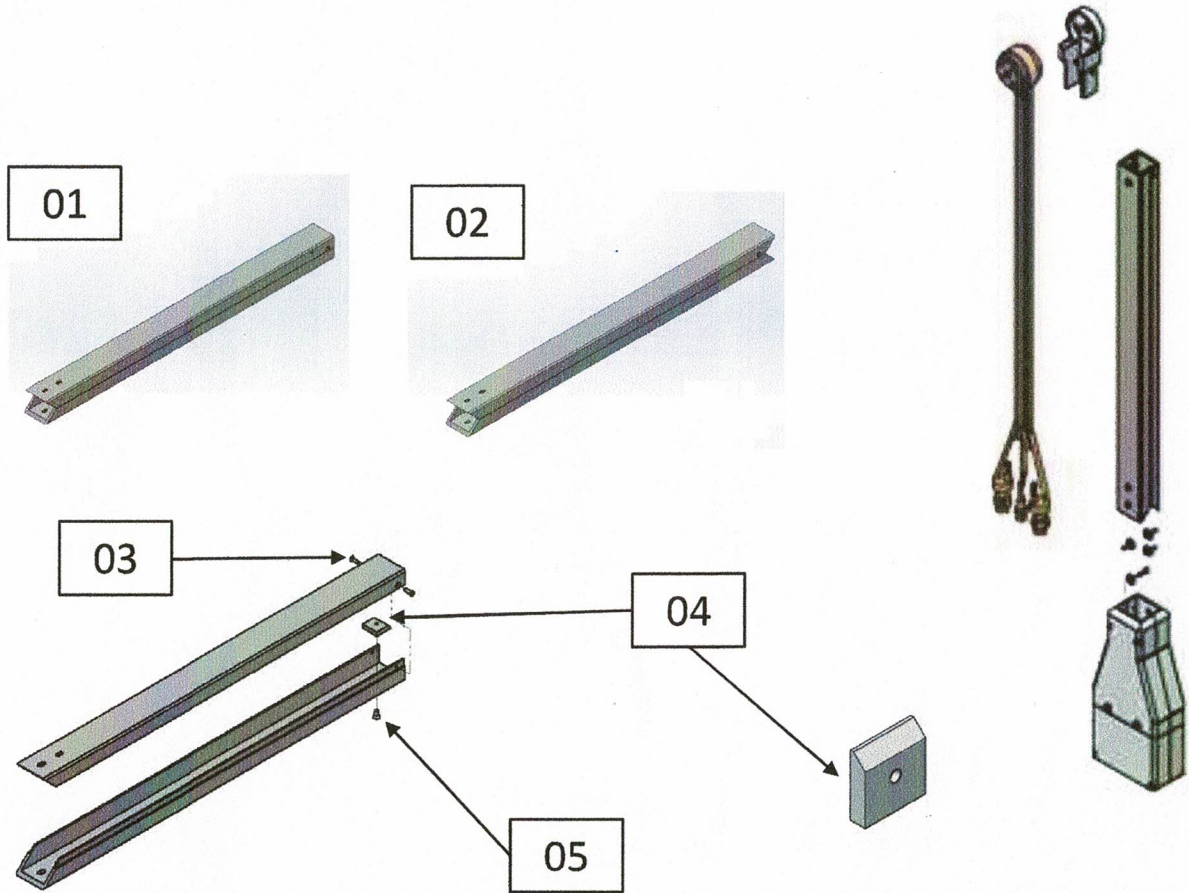

Position	Description	Art.-No.	Quantity 90°	Quantity 45°
01	Gun shell F1-90°, 500mm	CE-001372	1	
01	Gun shell F1-90°, 600mm	CE-001843	(1)	
01	Gun shell F1-90°, 700mm	CE-001844	(1)	
01	Gun shell F1-90°, 750mm	CE-001845	(1)	
02	Gun shell F1-45°, 500mm	CE-001371		1
02	Gun shell F1-45°, 600mm	CE-001840		(1)
02	Gun shell F1-45°, 700mm	CE-001841		(1)
02	Gun shell F1-45°, 750mm	CE-001842		(1)
03	Countersunk allen screw M3x6	CE-001821	2	2
04	Retainer key	CE-001808	1	1
05	Countersunk allen screw M4x8	CE-001917	1	1

Spare Parts List

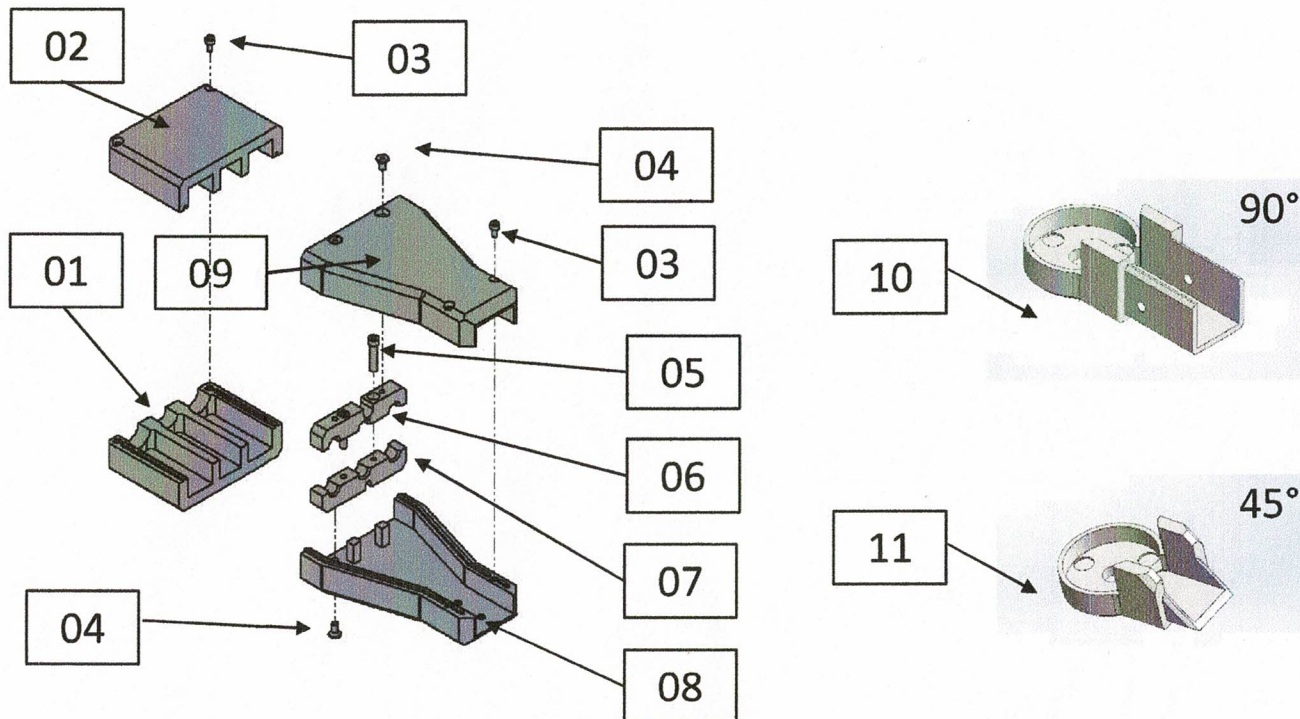

Position	Description	Art.-No.	Quantity 90°	Quantity 45°
01	Shell extension lower part	CE-002221	1	1
02	Shell extension upper part	CE-002220	1	1
03	Hex socket head cap Screw M4x25	CE-002060	4	4
04	Cuntersunk Screw M5x16	CE-001817	4	4
05	Hex socket head cap Screw M5x25	CE-002039	2	2
06	Holding down clamp upper part	CE-002222	1	1
07	Holding down clamp lower part	CE-002223	1	1
08	Gun shell lower part	CE-002224	1	1
09	Gun shell upper part	CE-002225	1	1
10	Insulation protection 90°	CE-001384	1	
11	Insulation protection 45°	CE-001383		1

Spare Parts List

01

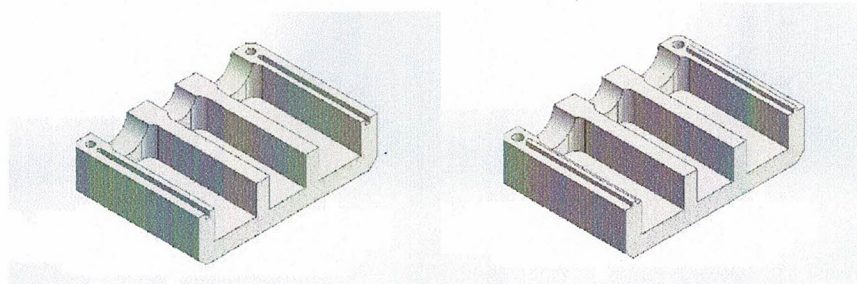

02

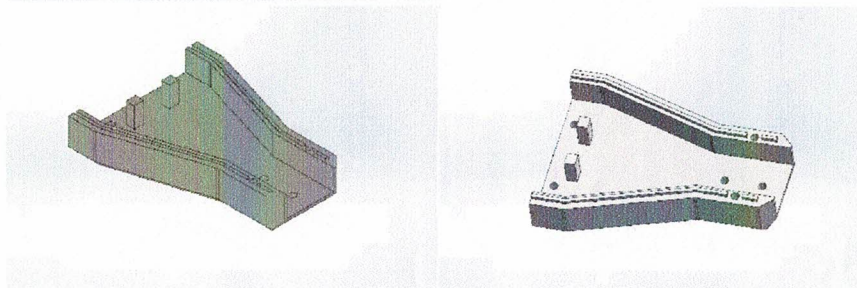

03

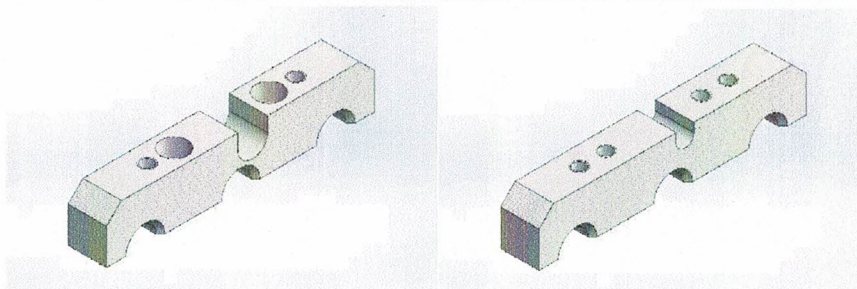

Position	Description	Art.-No.	Quantity 90°	Quantity 45°
01	SET - Shell extension upper and lower part incl. Screw	CE-001369	1	1
02	SET - Gun shell upper and lower part incl. Screw	CE-001370	1	1
03	SET - Holding down clamp upper and lower part incl. Screw	CE-002226	1	1

Accessory Parts

SET Burner Hose M16x1.5 Typ A +/-

SET Burner Hose M16x1.5 Typ A +/- à 1m	CE-000878-01
SET Burner Hose M16x1.5 Typ A +/- à 2m	CE-000878-02
SET Burner Hose M16x1.5 Typ A +/- à 3m	CE-000878-03
SET Burner Hose M16x1.5 Typ A +/- à 4m	CE-000878-04
SET Burner Hose M16x1.5 Typ A +/- à 5m	CE-000878-05
SET Burner Hose M16x1.5 Typ A +/- à 6m	CE-000878-06
SET Burner Hose M16x1.5 Typ A +/- à 7m	CE-000878-07
SET Burner Hose M16x1.5 Typ A +/- à 8m	CE-000878-08
SET Burner Hose M16x1.5 Typ A +/- à 9m	CE-000878-09
SET Burner Hose M16x1.5 Typ A +/- à 10m	CE-000878-10
SET Burner Hose M16x1.5 Typ A +/- à 11m	CE-000878-11
SET Burner Hose M16x1.5 Typ A +/- à 12m	CE-000878-12

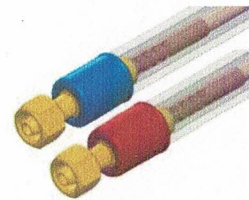

Burner Hose M16x1.5 Typ A Plus +

Burner Hose M16x1.5 Typ A Plus à 1m	CE-001500-01
Burner Hose M16x1.5 Typ A Plus à 2m	CE-001500-02
Burner Hose M16x1.5 Typ A Plus à 3m	CE-001500-03
Burner Hose M16x1.5 Typ A Plus à 4m	CE-001500-04
Burner Hose M16x1.5 Typ A Plus à 5m	CE-001500-05
Burner Hose M16x1.5 Typ A Plus à 6m	CE-001500-06
Burner Hose M16x1.5 Typ A Plus à 7m	CE-001500-07
Burner Hose M16x1.5 Typ A Plus à 8m	CE-001500-08
Burner Hose M16x1.5 Typ A Plus à 9m	CE-001500-09
Burner Hose M16x1.5 Typ A Plus à 10m	CE-001500-10
Burner Hose M16x1.5 Typ A Plus à 11m	CE-001500-11
Burner Hose M16x1.5 Typ A Plus à 12m	CE-001500-12



Burner Hose M16x1.5 Typ A Minus -

Burner Hose M16x1.5 Typ A Minus à 1m	CE-001505-01
Burner Hose M16x1.5 Typ A Minus à 2m	CE-001505-02
Burner Hose M16x1.5 Typ A Minus à 3m	CE-001505-03
Burner Hose M16x1.5 Typ A Minus à 4m	CE-001505-04
Burner Hose M16x1.5 Typ A Minus à 5m	CE-001505-05
Burner Hose M16x1.5 Typ A Minus à 6m	CE-001505-06
Burner Hose M16x1.5 Typ A Minus à 7m	CE-001505-07
Burner Hose M16x1.5 Typ A Minus à 8m	CE-001505-08
Burner Hose M16x1.5 Typ A Minus à 9m	CE-001505-09
Burner Hose M16x1.5 Typ A Minus à 10m	CE-001505-10
Burner Hose M16x1.5 Typ A Minus à 11m	CE-001505-11
Burner Hose M16x1.5 Typ A Minus à 12m	CE-001505-12



Accessory Parts

Powder injector holder

Powder injector holder F1-90° **CE-001812**



Powder injector holder F1-90°/50° **CE-001813**



Powder injector holder F1-90°/75° **CE-001811**

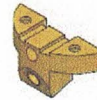

Powder injector holder F1-2x15° **CE-002227**



Powder injector G1/8"

Ø1.5 **CE-000749**

Ø1.8 **CE-000750**

Ø2.0 **CE-000751**



Powder injector 7/16-20 UNF

Ø1.5 **CE-000752**

Ø1.8 **CE-000753**

Ø2.0 **CE-000754**

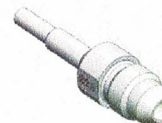

Powder injector G1/8" bent 15°

Ø1.5 **CE-000757**

Ø1.8 **CE-000758**

Ø2.0 **CE-000759**

Powder injector G1/8" bent 35°

Ø1.5 **CE-000760**

Ø1.8 **CE-000761**

Ø2.0 **CE-000762**

Accessory Parts

Gun holder

CE-000792

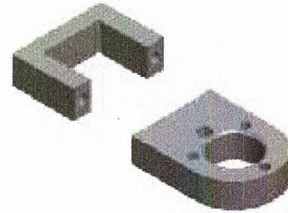

Plasma gas burner hose, 5m

CE-001121



Female connector G1/8" / 6x4

CE-000153

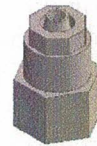

PTFE Tube 4.0x6.0mm with 20% carbon
XX-m

CE-001065

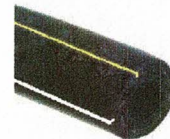

F1- Nozzle Pulling Tool 6mm

CE-001385



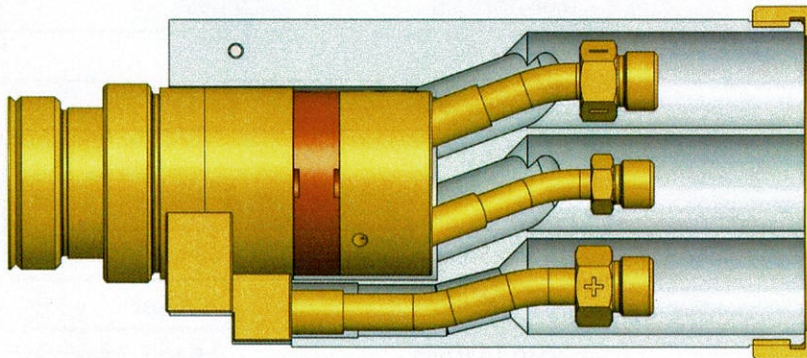
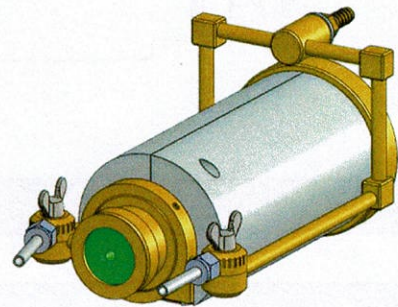
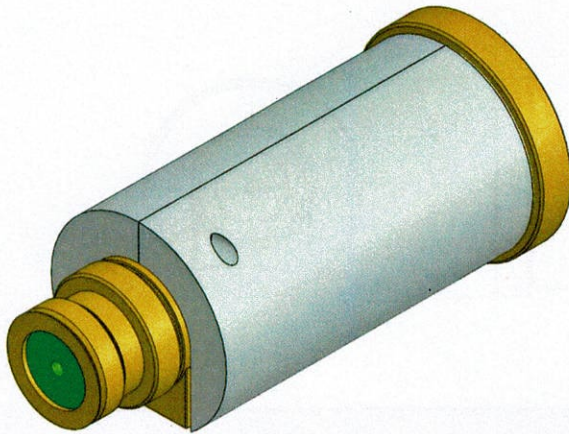

Spare parts

F4-MB Plasma-Spray Gun

Spare Parts List

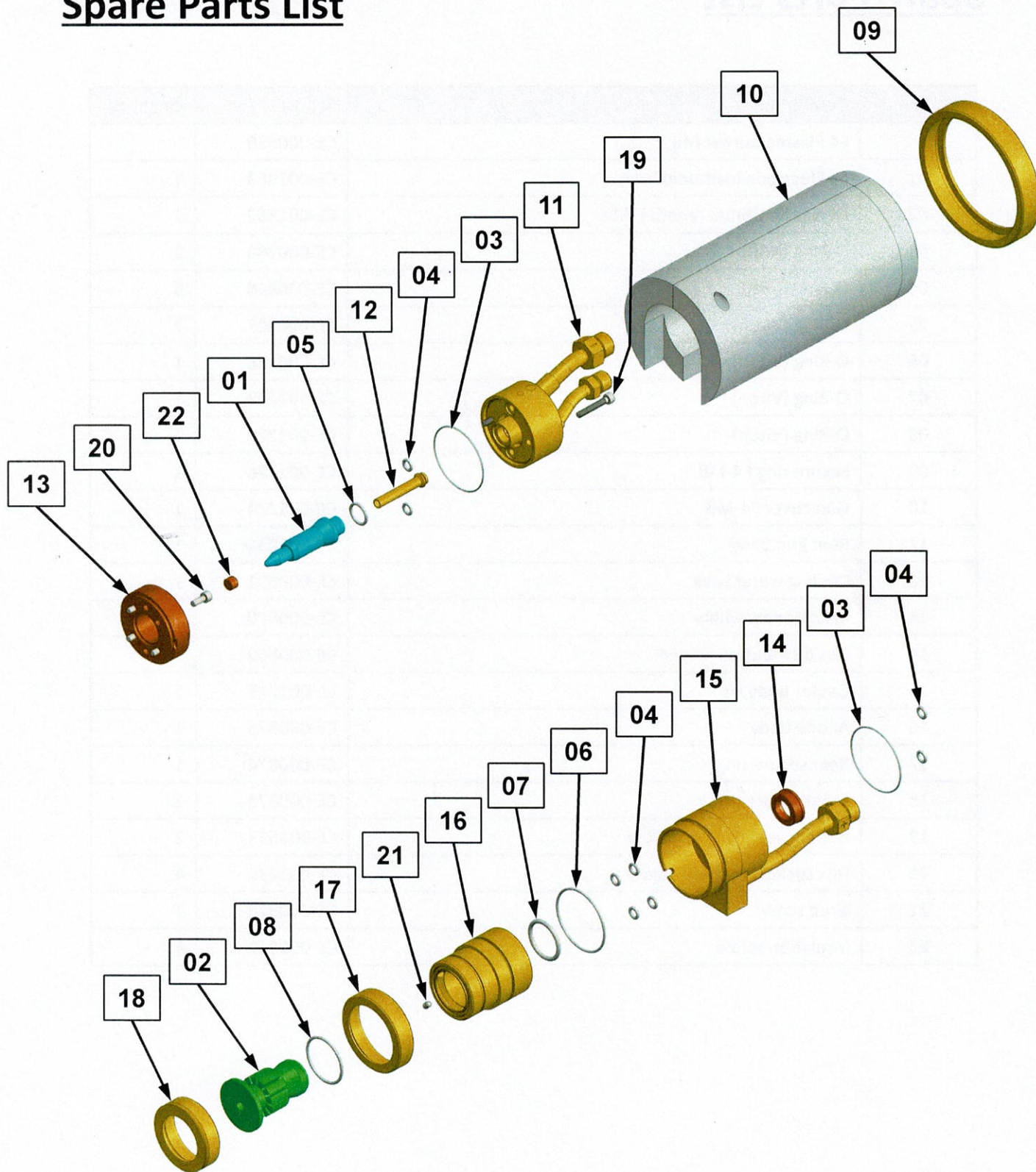

Spare Parts List

Position	Description	Art.-No.	Quantity
	F4 Plasma Burner MB	CE-000819	
01	F4 Electrode (cathode) WLa	CE-001363	1
02	F4 Nozzle Ø6mm (anode) WLa	CE-001362	1
03	O-Ring (NBR)	CE-000208	2
04	O-Ring (NBR)	CE-000866	8
05	O-Ring (Viton)	CE-000207	1
06	O-Ring (Viton)	CE-000146	1
07	O-Ring (Viton)	CE-001228	1
08	O-Ring (Viton)	CE-001229	1
09	Secure ring F4-MB	CE-001226	1
10	Gun cover F4-MB	CE-001224	1
11	Rear gun body	CE-001231	1
12	Cooling water tube	CE-000891	1
13	Insulator assembly	CE-000870	1
14	Gas distribution ring F4	CE-000869	1
15	Center body F4	CE-001225	1
16	Anode body	CE-000875	1
17	Rear secure ring	CE-000874	1
18	Front secure ring	CE-000873	1
19	Hex socket head cap screw	CE-001533	2
20	Hex socket head cap screw	CE-001230	4
21	Grub screw	CE-000948	1
22	Insulation screw	CE-000872	4

Accessory Parts

Powder injector holder

75°/75°

CE-000828

75°/90°

CE-000829

90°/90°

CE-000826

90°/90°/90°/90°

CE-000830

90°/90°/75°/105°

CE-000831

75°/90°/105°/105°

CE-000884

90°/90°/105°/105°

CE-000885

105°/105°

CE-000886

100°/100°

CE-000887

90°/100°

CE-000888

90°/105°

CE-000889

90°/90°/75°/75°

CE-000980

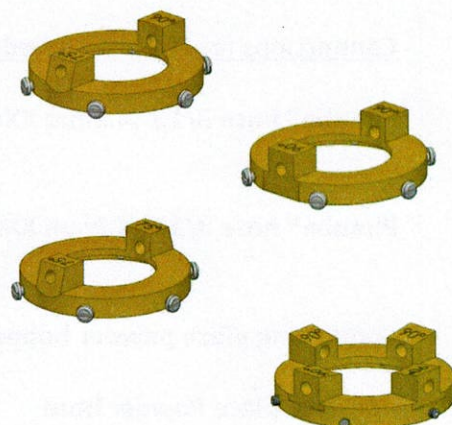

Connections for PTFE-tube 6x4 metrical system

Female connector G1/8« – 6x4

CE-000153

 PTFE tube 4.0x6.0mm with 20% carbon
XX-m

CE-001065-XX

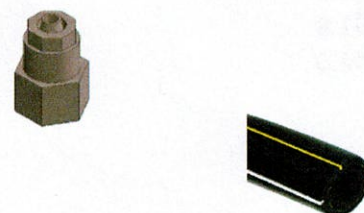

Powder injector G1/8"

Ø1.5

CE-000749

Ø1.8

CE-000750

Ø2.0

CE-000751



Powder injector G1/8" bent 15°

Ø1.5

CE-000757

Ø1.8

CE-000758

Ø2.0

CE-000759

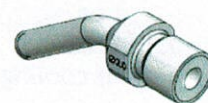

Powder injector G1/8" bent 35°

Ø1.5

CE-000760

Ø1.8

CE-000761

Ø2.0

CE-000762

Accessory Parts

Connections for Piranha® powder hose 3/16" conical system

Piranha® hose 3/16", 4.8mm XXm inkl. Fitting CE-002197-XX

Piranha® hose 3/16", 4.8mm XXm CE-001330-XX

Connecting piece powder hopper CE-001192

Interface piece Powder hose to powder hopper CE-001191

Interface piece Powder hose to powder injector conical CE-001190

Powder injector 7/16-20 UNF

Ø1.5 CE-000752

Ø1.8 CE-000753

Ø2.0 CE-000754

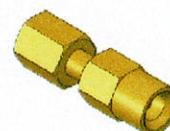

Distance ring set CE-000832

Adjusting tool for F4 burner electrode CE-000843

Gun holder CE-000792

F4 Air Jet

F4_Air cooling / Air-Jets CE-000478

F4_Nozzle 50mm to Air Jet CE-000481

F4_Nozzle 75mm to Air Jet CE-000479

F4_Nozzle 100mm to Air Jet CE-000480

Plasma gas burner hose, 5m CE-001121

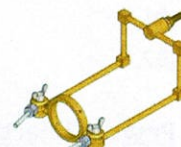

Accessory Parts

SET Burner Hose M16x1.5 Typ A +/-

SET Burner Hose M16x1.5 Typ A +/- à 1m
 SET Burner Hose M16x1.5 Typ A +/- à 2m
 SET Burner Hose M16x1.5 Typ A +/- à 3m
 SET Burner Hose M16x1.5 Typ A +/- à 4m
 SET Burner Hose M16x1.5 Typ A +/- à 5m
 SET Burner Hose M16x1.5 Typ A +/- à 6m
 SET Burner Hose M16x1.5 Typ A +/- à 7m
 SET Burner Hose M16x1.5 Typ A +/- à 8m
 SET Burner Hose M16x1.5 Typ A +/- à 9m
 SET Burner Hose M16x1.5 Typ A +/- à 10m
 SET Burner Hose M16x1.5 Typ A +/- à 11m
 SET Burner Hose M16x1.5 Typ A +/- à 12m

CE-000878-01
 CE-000878-02
 CE-000878-03
 CE-000878-04
 CE-000878-05
 CE-000878-06
 CE-000878-07
 CE-000878-08
 CE-000878-09
 CE-000878-10
 CE-000878-11
 CE-000878-12

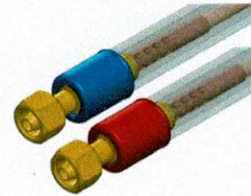

Burner Hose M16x1.5 Typ A Plus +

Burner Hose M16x1.5 Typ A Plus à 1m
 Burner Hose M16x1.5 Typ A Plus à 2m
 Burner Hose M16x1.5 Typ A Plus à 3m
 Burner Hose M16x1.5 Typ A Plus à 4m
 Burner Hose M16x1.5 Typ A Plus à 5m
 Burner Hose M16x1.5 Typ A Plus à 6m
 Burner Hose M16x1.5 Typ A Plus à 7m
 Burner Hose M16x1.5 Typ A Plus à 8m
 Burner Hose M16x1.5 Typ A Plus à 9m
 Burner Hose M16x1.5 Typ A Plus à 10m
 Burner Hose M16x1.5 Typ A Plus à 11m
 Burner Hose M16x1.5 Typ A Plus à 12m

CE-001500-01
 CE-001500-02
 CE-001500-03
 CE-001500-04
 CE-001500-05
 CE-001500-06
 CE-001500-07
 CE-001500-08
 CE-001500-09
 CE-001500-10
 CE-001500-11
 CE-001500-12



Burner Hose M16x1.5 Typ A Minus -

Burner Hose M16x1.5 Typ A Minus à 1m
 Burner Hose M16x1.5 Typ A Minus à 2m
 Burner Hose M16x1.5 Typ A Minus à 3m
 Burner Hose M16x1.5 Typ A Minus à 4m
 Burner Hose M16x1.5 Typ A Minus à 5m
 Burner Hose M16x1.5 Typ A Minus à 6m
 Burner Hose M16x1.5 Typ A Minus à 7m
 Burner Hose M16x1.5 Typ A Minus à 8m
 Burner Hose M16x1.5 Typ A Minus à 9m
 Burner Hose M16x1.5 Typ A Minus à 10m
 Burner Hose M16x1.5 Typ A Minus à 11m
 Burner Hose M16x1.5 Typ A Minus à 12m

CE-001505-01
 CE-001505-02
 CE-001505-03
 CE-001505-04
 CE-001505-05
 CE-001505-06
 CE-001505-07
 CE-001505-08
 CE-001505-09
 CE-001505-10
 CE-001505-11
 CE-001505-12



F4-MB PLASMA GUN			
Pos.	FST p/n	Product Description	OEM / Remark
	300.000-01	F4-MB Plasma gun complete	–
	300.000-02	F4-HB Plasma gun complete	–
	300.000-04	F4-VB Plasma gun complete	–
1	300.001	Secure ring	310017
2	300.002-01	Gun cover F4-MB (shell halves)	310013
	300.002-02	Gun cover F4-HB (shell halves)	300013
	300.002-03	Gun cover F4-HBS (shell halves)	301013
3	300.003-01	Screw	300142
	300.003-02	Screw, for F4-HB Gun	300014
	300.003-03	Screw, for F4-HBS Gun	300145
4	300.061	O-Ring, 44 x 1 mm	300005
5	300.060	O-Ring, 42 x 1.5 mm	300041
6	300.010	Insulating screws	300140
7	300.006	Cooling water tube	300009
8	300.003-01	Screw	300142
9	300.004-01	Rear gun body, for F4-MB	310010
	300.004-02	Rear gun body, for F4-HB	300010
	300.004-03	Rear gun body, for F4-HBS	301010
10	300.005	O-Ring (gun body)	300031
11	300.021	Set screw for anode holder	300139
12	300.007	O-Ring electrode	300032
13*	300.008	Electrode, for N2	300001
	300.056	Electrode, 'short' for N2	300056
14	300.018	Gas distribution ring	300081
15	300.013	Screws M4x10	300141
16	300.015	Intermediate body	300080
17	300.020-01	Center Body, for F4-MB	310007
	300.020-02	Center Body, for F4-HB	300007
	300.020-03	Center Body, for F4-HBS	301007
18	300.022	Anode Body	300006
	300.023	Anode Body, 'short' for N2	300023
19	300.024	O-Ring nozzle rear	300034
20**	300.025	Nozzle F4, 5 mm	300022
	300.027	Nozzle F4, 6mm	300002

* : All electrodes include O-Ring 300.007

** : All nozzles include O-Rings 300.024 + 300.033

F4-MB PLASMA GUN			
Pos.	FST p/n	Product Description	OEM / Remark
20**	300.029	Nozzle F4, 7 mm	300002-10
	300.031	Nozzle F4, 8mm	300002-20
	300.057	Nozzle F4, 6mm, 'short' for N2	300046
	300.059	Nozzle F4, 8mm, 'short' for N2	-
21	300.033	O-Ring nozzle front	300033
22	300.034	Rear secure ring	300012
23	300.035	Front secure ring	300004
24	300.036	Screws M3x5	300143
25	300.037-01	Injector holder, 90/75, standard	300015
	300.037-02	Injector holder, 90/105	300050
	300.037-03	Double injector holder, 90/90	300016
	300.037-04	Injector holder, 105/90/75	-
26	380.001	Powder injector 1.5 mm	300019
	380.002	Powder injector 1.8 mm	300020
	380.003	Powder injector 2.0 mm	300021
26a	380.042	Nut M5	300144
OTHERS			
	300.054	Nozzle/Electrode set, 6mm	300003
	300.055	Nozzle/Electrode set, 6mm, 'short' for N2	300072
	300.065	Complete O-Ring set	-
	300.063	Electrode centering tool w/gauge	300060
	300.066	Cooling jet holder complete	300090-06
CABLES, HOSES, FITTINGS			
	380.022-01	Plasma gun power cable set	for F1/F4 gun, length 5 m
	380.020-01	Plasma gun power cable (negative)	for F1/F4 gun, length 5 m
	380.021-01	Plasma gun power cable (positive)	for F1/F4 gun, length 5 m
	380.023-01	Plasma gas hose	for F1/F4 gun, length 5 m
	380.022-02	Plasma gun power cable set	for F1/F4 gun, length 6 m
	380.020-02	Plasma gun power cable (negative)	for F1/F4 gun, length 6 m
	380.021-02	Plasma gun power cable (positive)	for F1/F4 gun, length 6 m
	380.023-02	Plasma gas hose	for F1/F4 gun, length 6 m
	500.001	Powder feed hose	-
	500.021	Powder feed hose screw fitting	for powder hose 500.001

* : All electrodes include O-Ring 300.007

** : All nozzles include O-Rings 300.024 + 300.033

F1-45° / F1-90° PLASMA GUNS			
Pos.	FST p/n	Product Description	OEM / Remark
	301.000-01	F1-45 Gun	344000
	301.000-02	F1-90 Gun	340000
1,2,3,4	301.001-01	Shells complete for F1-45 gun	344011, for F1-45 Gun
	301.001-02	Shells complete for F1-90 gun	340011, for F1-90 Gun
5	301.006	Holder	340015
6	301.028	Socket head cap screw	for F1 gun shells
7	301.029	Socket head cap screw for holder	for F1 gun holder
8	301.002-01	Cover	344012, for F1-45 Gun
	301.002-02	Cover	340012, for F1-90 Gun
9	301.007	Insulating sleeves and covers	340005
10	301.008	Screw, M3x16	300146
11	301.009	Centering pin	340060
12	301.010-02	Electrode, screw type	340001, for F1-90 Gun
12a	301.010-01	Electrode, plug type	343001, for F1-45 Gun
12b	301.011	Screw for electrode	343010, for F1-45 Gun
13	301.012-01	Rear section complete	344010, for F1-45 Gun
	301.012-02	Rear section complete	340010, for F1-90 Gun
14	301.005	Connecting hose	300138
15	301.004	Connecting hose clamp	300137
16	301.013	Gas distribution ring	340020
17,18,19	301.014-00	Intermediate section complete	344017-00
20	301.015-01	Front section	344009, for F1-45 Gun
	301.015-02	Front section	340009, for F1-90 Gun
21	301.016	O-Ring, 18 x 2 mm	343007
22	301.017	O-Ring, 19 x 1.5 mm	340008
23*	301.018	Nozzle, 5 mm	340002
	301.019	Nozzle, 6 mm	343002
	301.020	Nozzle, 7 mm	–
24	301.022	Injector support standard	340050
25	301.023	Nozzle screws, M3x10	300147
26	301.021	Locknut, M5	300144
27	380.001	Powder injector 1.5 mm	300019
	380.002	Powder injector 1.8 mm	300020
	380.003	Powder injector 2.0 mm	300021
	380.004	Powder injector 1.5 mm	344019, bent

* : All nozzles include O-Rings 301.016 + 301.017

F1-45° / F1-90° PLASMA GUNS			
Pos.	FST p/n	Product Description	OEM / Remark
	380.005	Powder injector 1.8 mm	344020, bent
	380.006	Powder injector 2.0 mm	344021, bent
28	301.024	Gun holder complete	340016
29	301.003	Screws, M3x6	300148
OTHERS*			
	301.014-00	Intermediate section complete	344017-00, incl. 301.014-01, -02, -03
	301.025-01	Nozzle/Electrode/O-Ring set, 5 mm, plug type	340003-05
	301.025-02	Nozzle/Electrode/O-Ring set, 5 mm, screw type	340003-05
	301.026-01	Nozzle/Electrode/O-Ring set, 6 mm, plug type	343003-06
	301.026-02	Nozzle/Electrode/O-Ring set, 6 mm, screw type	343003-06
	301.027-01	Nozzle/Electrode/O-Ring set, 7 mm, plug type	–
	301.027-02	Nozzle/Electrode/O-Ring set, 7 mm, screw type	–
CABLES, HOSES, FITTINGS			
	380.022-01	Plasma gun power cable set	for F1/F4 gun, length 5 m
	380.020-01	Plasma gun power cable (negative)	for F1/F4 gun, length 5 m
	380.021-01	Plasma gun power cable (positive)	for F1/F4 gun, length 5 m
	380.023-01	Plasma gas hose	for F1/F4 gun, length 5 m
	380.022-02	Plasma gun power cable set	for F1/F4 gun, length 6 m
	380.020-02	Plasma gun power cable (negative)	for F1/F4 gun, length 6 m
	380.021-02	Plasma gun power cable (positive)	for F1/F4 gun, length 6 m
	380.023-02	Plasma gas hose	for F1/F4 gun, length 6 m
	500.001	Powder feed hose	–
	500.021	Powder feed hose screw fitting	for powder hose 500.001
	500.032-01	4MP Powder Hose (15ft)	
	500.032-02	4MP Powder Hose (20ft)	
	500.032-03	4MP Powder Hose (30ft)	
	500.032-05	4MP Powder Hose Orange(15ft)	
	500.032-06	4MP Powder Hose Orange(25ft)	
		Other lengths available on request	

* : All nozzles include O-Rings 301.016 + 301.017

3MB PLASMA GUN			
Pos.	FST p/n	Product Description	OEM / Remark
	304.000-01	3MB gun complete, machine mounted	–
	304.000-02	3MB gun complete, hand held	–
1	304.006	Electrode holder	3M184A
2	304.001	Electrode assembly	3M11A
3	304.034	Electrode locking nut-black	3M276A
4	304.017	O-Ring, electrode holder	3M198A
5	304.018	O-Ring, electrode assembly	3M199A
6	304.007	Mounting bracket mounting screw	3M185A
7	304.005	Mounting bracket	3M183A
8	304.009	Rear gun body assembly	3M188A
9	304.014	O-Ring, front and rear gun body	3M195A
10	304.015	O-Ring, gun bodies and nozzle	3M196A
11	304.012	Screw-rear gun body	3M192A
12	304.002	Screw front gun body	3M168A
13	304.010	Insulator and hose assembly	3M189A
	304.010-01	Insulator hose 6" (hose only)	–
14	304.033-01	Distribution ring, 1-hole argon	3M275A
	304.033-02	Distribution ring, 2-hole nitrogen	–
15	304.008	Front gun body assembly	3M187A
16	304.016	O-Ring, nozzle, rear	3M197A
17	304.011	Nozzle locking ring	3M190A
18	380.100-01	"G" nozzle	3M7A-G
	380.100-02	"G" nozzle with tungsten insert	3M7A-G
	380.101-01	"GE" nozzle	3M7A-GE
	380.101-02	"GE" nozzle with tungsten insert	3M7-GE
	380.102-01	"GH" nozzle	3M7A-GH
	380.102-02	"GH" nozzle with tungsten insert	3M7-GH
	380.103-01	"GP" nozzle	3M7A-GP
19	304.046	Handle screw	3M43A
20	304.003	Handle nut	3M176A
21	304.019	Handle assembly, hand held	3M200A
22	304.086	Handle assembly, machine mounted	3M200A-1

3MB PLASMA GUN			
Pos.	FST p/n	Product Description	OEM / Remark
OTHERS			
	304.013	Wrench for nozzle locking ring	3M193A
	304.023	Spare O-Rings	3M206A
	304.031	Mounting bracket	3M268
	304.032	Tool post stud assembly	3M269
	304.042	Plug	3M340
	304.043	Switch	3M341
CABLES, HOSES, FITTINGS			
	304.053-01	Plasma gas hose assembly, 20 ft.	3M336
	304.053-02	Plasma gas hose assembly, 15 ft.	3M336
	304.054-01	Nozzle hose & cable assembly, positive, 20 ft.	3M-394
	304.054-02	Nozzle hose & cable assembly, positive, 15 ft.	3M-394
	304.055-01	Electrode hose & cable assembly, negative, 20 ft.	3M-395
	304.055-02	Electrode hose & cable assembly, negative, 15 ft.	3M-395
	304.080	Adapter, 3MB gun - 7M/9M hose (left hand)	3M-797
	304.081	Adapter, 3MB gun - 7M/9M hose (right hand)	3M-798
	500.032-01	4MP Powder Hose (15ft)	
	500.032-02	4MP Powder Hose (20ft)	
	500.032-03	4MP Powder Hose (30ft)	
	500.032-05	4MP Powder Hose Orange(15ft)	
	500.032-06	4MP Powder Hose Orange(25ft)	
		Other lengths available on request	

3MBT-30° / 3MBT-90° PLASMA GUNS			
Pos.	FST p/n	Product Description	OEM / Remark
	304.000-03	3MBT ID Plasma gun complete	24", 30 degrees
	304.000-04	3MBT ID Plasma gun complete	24", 90 degrees
1	304.101-01	Gun cover, 18"	
	304.101-02	Gun cover, 24"	
1a	304.102	Gun cover front, 30 degrees	
2	304.103-01	Extension arm, 18"	
	304.103-02	Extension arm, 24"	
	304.104-01	Extension arm, 18", 30 degrees	
	304.104-02	Extension arm, 24", 30 degrees	
3	304.105	Insulator hose adaptor, gas	3M 794
4	304.016	O-Ring, nozzle, rear + electrode holder 2x	3M 197
6	304.107	Electrode holder	
7	304.018	O-Ring, electrode assembly	3M 199
8	304.001	Electrode	3M 11
9	304.080	Adapter, 3MB gun - 7M/9M hose (left hand)	3M-797
10	304.108	Cable connector, negative	
11	304.002	Screw front gun body (4 ea. req)	3M 168
12	304.109-01	Gun body, rear, 90 degrees	3M 392
	304.109-02	Gun body, rear, 30 degrees	3M 392
13	304.015	O-Ring, front gun body and nozzle	3M 196
14	304.014	Cooling water O-Ring	3M 195
15	304.033-01	Distribution ring, 1-hole argon	3M 275A
	304.033-02	Distribution ring, 2-hole nitrogen	3M 275N
16	304.110-01	Insulator assembly, 90 degrees, 18"	
	304.110-02	Insulator assembly, 30 degrees, 18"	
	304.110-03	Insulator assembly, 90 degrees, 24"	
	304.110-04	Insulator assembly, 30 degrees, 24"	
17	304.081	Adapter, 3MB gun - 7M/9M hose (right hand)	3M 798
18	304.111	Cable connector, positive	
19	304.008	Front gun body assembly, 90 degrees	3M 187
	304.112	Front gun body assembly, 30 degrees	
20	304.113	Adapter block	3M 744
21	304.007	Mounting bracket mounting screw	3M 185
22	304.114	Cap cover, front shield	
23	304.115	Screw, cap mount	3M 397
24	380.100-01	"G" nozzle	3M7-G
	380.101-01	"GE" nozzle	3M7-GE
	380.102-01	"GH" nozzle	3M7-GH
	380.103-01	"GP" nozzle	3M7-GP

3MBT-30° / 3MBT-90° PLASMA GUNS			
Pos.	FST p/n	Product Description	OEM / Remark
25	304.011	Nozzle locking ring	3M 190
26	304.116	Screw	
27	304.117	Clamp, single powder port, with air jet	
28	304.012	Screw, rear gun body	3M 192
29	381.136	Locking screw	3M 327
30	304.118	Air jet nozzle	
31	381.020-01	#2 Powder port assembly	3M325
	381.001	Powder port stem	3M202
	381.021	#2 Tip	3M210A
	381.022-01	#2 Mounting block	3M211A
32	304.119-01	Air tube / Powder tube, 18"	
	304.119-02	Air tube / Powder tube, 24"	
	304.120-01	Air tube / Powder tube, 18", 30 degrees	
	304.120-02	Air tube / Powder tube, 24", 30 degrees	
33	304.121	Tube mounting bracket	
34	304.055-04	Electrode hose & cable assembly, negative, 5 ft.	3M-395
35	304.054-04	Nozzle hose & cable assembly, positive, 5 ft.	3M-394
OTHERS			
	381.010-01	#1 Powder Port Assembly	3M320
	381.030-01	#3 Powder Port Assembly	3M330
	381.040-01	#4 Powder Port Assembly	3M350
	381.050-01	#5 Powder Port Assembly	3M245
	381.060-01	#6 Powder Port Assembly	3M285
		Clamp, single powder port, no air jet	
		Clamp, dual powder port, no air jet	
CABLES, HOSES, FITTINGS			
	304.053-01	Plasma gas hose assembly, 20 ft.	3M 336
	304.053-02	Plasma gas hose assembly, 15 ft.	3M 336
	304.054-01	Nozzle hose & cable assembly, positive, 20 ft.	3M-394
	304.054-02	Nozzle hose & cable assembly, positive, 15 ft.	3M-394
	304.055-01	Electrode hose & cable assembly, negative, 20 ft.	3M-395
	304.055-02	Electrode hose & cable assembly, negative, 15 ft.	3M-395
	500.032-01	4MP Powder Hose (15ft)	
	500.032-02	4MP Powder Hose (20ft)	
	500.032-03	4MP Powder Hose (30ft)	
	500.032-05	4MP Powder Hose Orange(15ft)	
	500.032-06	4MP Powder Hose Orange(25ft)	
		Other lengths available on request	

9MB PLASMA GUN (machine mounted)			
Pos.	FST p/n	Product Description	OEM / Remark
	306.000-01	Complete 9MB Plasma gun, machine mounted	Machine mounted version
1	306.090	Cable support strap assembly	9MB 301
2	306.067	Locking ring assembly	9MB 142
3	306.064	Electrode holder clamp & hose fitting	9MB 135
4	306.065	Screw, electrode holder clamp	9MB 138
5	306.018	Electrode holder nut	9MB 17
6	306.069	Rear insulator	9MB 166
7	306.021	O-Ring, rear insulator	9MB 21
8	306.033	O-Ring, insulator, rear	9MB 46
9	306.087	O-Ring, front insulator	9MB 296
10	306.035	Front insulator assembly, 2-hole argon	9MB 50, including O-Rings
	306.039	Front insulator assembly, nitrogen	9MB 55, including O-Rings
	306.155	Front insulator assembly, 6-hole argon	9MB 60, including O-Rings
11	306.019	Electrode holder assembly	9MB 18
12	306.043	O-Ring, electrode holder	9MB 56
13	306.038	O-Ring, electrode holder	9MB 52
14	306.060	O-Ring, electrode holder, rear insulator, nozzle	9MB 111
15	306.037	O-Ring, electrode	9MB 51
16	306.047	Electrode	9MB 63, including O-Ring
17	306.016	Electrode locking nut	9MB 14
18	306.074	Hose fitting (plasma gas)	9MB 208
19	306.030	Base Sub. assembly, machine mount	9MB 37
20	306.031	Plug screw	9MB 38
21	306.025	O-Ring, machine mount base	9MB 29
22	306.017	Gun water channeling head	9MB 15, including 9MB 297
23	380.100-01	"G" nozzle	3M7-G, 7M7-G, 9MB7-G
	380.100-02	"G" nozzle with tungsten insert	3M7-G, 7M7-G, 9MB7-G
	380.101-01	"GE" nozzle	3M7-GE, 7M7-GE, 9MB7-GE
	380.101-02	"GE" nozzle with tungsten insert	3M7-GE, 7M7-GE, 9MB7-GE
	380.102-01	"GH" nozzle	3M7-GH, 7M7-GH, 9MB7-GH
	380.102-02	"GH" nozzle with tungsten insert	3M7-GH, 7M7-GH, 9MB7-GH
	380.103-01	"GP" nozzle	3M7-GP, 7M7-GP, 9MB7-GP
	306.005	700 Nozzle assembly, std	9MB 700
	306.164	703 nozzle assembly	9MB 703
	306.165	704 nozzle assembly	9MB 704

9MB PLASMA GUN (machine mounted)			
Pos.	FST p/n	Product Description	OEM / Remark
	306.166	705 nozzle assembly	9MB 705
	306.167	706 nozzle assembly	9MB 706
	306.168	707 nozzle assembly	9MB 707
24	306.044	O-Ring, nozzle, large	9MB 57
25	306.015	Nozzle nut	9MB 8
26	306.086	O-Ring, valve, small	9MB 295
27	306.097	Hose fitting & mounting stud assembly	9MB 335
OTHERS			
	306.088	O-Ring, water channeling head	9MB 297
	306.106	Electrode & Insulator assembly	9MB 693, 2-hole argon
	306.107	Electrode & Insulator assembly	9MB 694, nitrogen
	306.079	Lock washer, cable support strap assembly	9MB 221
	306.099	Screw, cable support strap assembly	9MB 453
CABLES, HOSES, FITTINGS			
	380.024-01	Plasma gun power cable (negative), 20 ft	7MH20-20, for 7M/9M gun, length 20 ft
	380.024-02	Plasma gun power cable (negative), 15 ft	7MH20-15, for 7M/9M gun, length 15 ft
	380.026-01	Plasma gun power cable (positive), 20 ft	7MH10-20, for 7M/9M gun, length 20 ft
	380.026-02	Plasma gun power cable (positive), 15 ft	7MH10-15, for 7M/9M gun, length 15 ft
	380.025-01	Plasma gas hose assembly 20 ft	7MH50-20, for 7M/9M gun, length 20 ft
	380.025-02	Plasma gas hose assembly 15 ft	7MH50-15, for 7M/9M gun, length 15 ft
	380.027-01	Plasma gun power cable set (positive/negative)	length 5 m
	380.027-02	Plasma gun power cable set (positive/negative)	length 6 m
	380.027-03	Plasma gun power cable set (positive/negative)	length 10 m
	380.027-04	Plasma gun power cable set (positive/negative)	length 8 m
	500.032-01	4MP Powder Hose (15ft)	
	500.032-02	4MP Powder Hose (20ft)	
	500.032-03	4MP Powder Hose (30ft)	
	500.032-05	4MP Powder Hose Orange(15ft)	
	500.032-06	4MP Powder Hose Orange(25ft)	
		Other lengths available on request	

9MB PLASMA GUN (hand held)			
Pos.	FST p/n	Product Description	OEM / Remark
	306.000-02	Complete 9MB Plasma gun, hand held	Handheld version
1	306.026	Rear gun body assembly	9MB 30
2	305.015	Screw, clamp	9MB 670
3	306.018	Electrode holder nut	9MB 17
4	306.169	Screw, support bracket mounting	9MB 115
5	306.062	Lock washer, support bracket screw	9MB 121
6	306.057	Support bracket	9MB 95
7	306.024	Front gun body assembly	9MB 25, for handheld version
8	306.045	Hose assembly, front gun body	9MB 58
9	306.025	O-Ring, front gun body	9MB 29
10	306.021	O-Ring, rear insulator	9MB 21
11	306.033	O-Ring, insulator, rear	9MB 46
12	306.069	Rear insulator	9MB 166
13	306.087	O-Ring, front insulator	9MB 296
14	306.035	Front insulator assembly, 2-hole argon	9MB 50, including O-Rings
	306.039	Front insulator assembly, nitrogen	9MB 55, including O-Rings
	306.155	Front insulator assembly, 6-hole argon	9MB 60, including O-Rings
15	306.043	O-Ring, electrode holder	9MB 56
16	306.019	Electrode holder assembly	9MB 18
17	306.038	O-Ring, electrode holder	9MB 52
18	306.060	O-Ring, electrode holder, rear insulator, nozzle	9MB 111
19	306.037	O-Ring, electrode	9MB 51
20	306.016	Electrode locking nut	9MB 14
21	306.047	Electrode	9MB 63, including O-Ring
22	306.027	Insulator, water cooled cable	9MB 32
23	306.017	Gun water channeling head	9MB 15, including O-Ring
24	380.100-01	"G" nozzle	3M7-G, 7M7-G, 9MB7-G
	380.100-02	"G" nozzle with tungsten insert	3M7-G, 7M7-G, 9MB7-G
	380.101-01	"GE" nozzle	3M7-GE, 7M7-GE, 9MB7-GE
	380.101-02	"GE" nozzle with tungsten insert	3M7-GE, 7M7-GE, 9MB7-GE
	380.102-01	"GH" nozzle	3M7-GH, 7M7-GH, 9MB7-GH
	380.102-02	"GH" nozzle with tungsten insert	3M7-GH, 7M7-GH, 9MB7-GH
	380.103-01	"GP" nozzle	3M7-GP, 7M7-GP, 9MB7-GP
	306.005	700 Nozzle assembly	9MB 700
	306.164	703 nozzle assembly	9MB 703
	306.165	704 nozzle assembly	9MB 704

9MB PLASMA GUN (hand held)			
Pos.	FST p/n	Product Description	OEM / Remark
	306.166	705 nozzle assembly	9MB 705
	306.167	706 nozzle assembly	9MB 706
	306.168	707 nozzle assembly	9MB 707
25	306.044	O-Ring, nozzle, large	9MB 57
26	306.015	Nozzle nut	9MB 8
OTHERS			
	306.148	Gun handle assembly	9MB 575
	306.088	O-Ring, water channeling head	9MB 297
	306.106	Electrode & Insulator assembly	9MB 693, 2-hole argon
	306.107	Electrode & Insulator assembly	9MB 694, nitrogen
CABLES, HOSES, FITTINGS			
	380.024-01	Plasma gun power cable (negative), 20 ft	7MH20-20, for 7M/9M gun, length 20 ft
	380.024-02	Plasma gun power cable (negative), 15 ft	7MH20-15, for 7M/9M gun, length 15 ft
	380.026-01	Plasma gun power cable (positive), 20 ft	7MH10-20, for 7M/9M gun, length 20 ft
	380.026-02	Plasma gun power cable (positive), 15 ft	7MH10-15, for 7M/9M gun, length 15 ft
	380.025-01	Plasma gas hose assembly 20 ft	7MH50-20, for 7M/9M gun, length 20 ft
	380.025-02	Plasma gas hose assembly 15 ft	7MH50-15, for 7M/9M gun, length 15 ft
	380.027-01	Plasma gun power cable set (positive/negative)	length 5 m
	380.027-02	Plasma gun power cable set (positive/negative)	length 6 m
	380.027-03	Plasma gun power cable set (positive/negative)	length 10 m
	380.027-04	Plasma gun power cable set (positive/negative)	length 8 m
	500.032-01	4MP Powder Hose (15ft)	
	500.032-02	4MP Powder Hose (20ft)	
	500.032-03	4MP Powder Hose (30ft)	
	500.032-05	4MP Powder Hose Orange(15ft)	
	500.032-06	4MP Powder Hose Orange(25ft)	
		Other lengths available on request	

SG-100 PLASMA GUN			
Pos.	FST p/n	Product Description	OEM / Remark
	307.000	SG-100 Plasma Gun	–
1	307.039	Tube, arc gas port, assembly	1083-10
2	307.038	Gun housing, rear	1083B-205
3	307.046	O-Ring, rear housing	2-010S
4	307.028	Cathode holder	1083A-108, fine thread
5	307.026	Cathode, NVS	1083A-720, non-vortex stabilized
	307.025	Cathode, sub-sonic	3083-129
	307.001	Cathode, Mach 1	1083A-112
	307.027	Cathode, Mach 2	1083A-104
6	307.065	O-Ring, cathode holder	2-017S
7	307.002	Gun housing, middle, insulator	1083A-122N
8	307.066	O-Ring, middle housing	2-022S
9	307.042	O-Ring, middle housing	2-024S
10	307.029	Gas injector NVS, 4 Holes, all gases.	3083-112, non-vortex stabilized
	307.007	Gas Injector, Sub-sonic/Mach 1, CW vortex, 4 Holes, all gases	3083-113
	307.030	Gas injector, Mach 2, std (brown), CW vortex, 16 holes, all gases	3083-110
	307.032	Gas injector, Mach 2, CW vortex, 16 Holes, Ar-He only	1083A-110
	307.033	Gas injector, 8 hole, Laminar, put s at Hole(s), all gases	2083-112-8
	307.031	Gas injector, 8 hole, Laminar, put s at Hole(s), all gases	5003644
11	307.036	Tube, powder, straight	1083B-210
	307.035	Tube, powder, 90 deg.	5004378
12	307.067	Screw, powder tube	7000611
13	307.040	Plug, powder port	1083A-107A
14	307.048	O-Ring, nozzle / powder port plug	2-006S
15	307.037	Gun housing, front	1083B-200
16	307.044	O-Ring, front housing	2-128S
17	307.068	Screw, insulator housing	7000435
18	307.013	Anode, forward injection, NVS	2083-730, 20° front, non-vortex stabilized
	307.023	Anode, forward injection, sub-sonic	3083-145, 10° front
	307.008	Anode, backward injection, sub-sonic	3083-165, 10° back
	307.021	Anode, straight injection, sub-sonic	3083-175, 90°
	307.022	Anode, Mach 1	2083-355
	307.014	Anode, Mach 1	2083-358
	307.005	Anode, backward injection, Mach 1	2083-155, 10° back
	307.017	Anode, Mach 2, forward injection	2083-100, 10° front

SG-100 PLASMA GUN			
Pos.	FST p/n	Product Description	OEM / Remark
	307.016	Anode, Mach 1, backward injection	2083-611, 10° back
	307.024	Anode, sub-sonic	2083-484
19	307.043	O-Ring, front housing	2-025S
20	307.047	O-Ring, nozzle	2-020S
21	307.034	Plate, front cover, standard	2083-123
22	307.049	O-Ring, front cover plate	2-026S
23	307.045	O-Ring, front cover plate	2-014S
24	307.069	Screw, front cover plate	7000422
OTHERS			
	307.041	O-Ring kit for SG-100	2083-601
	307.081	Anode hook	
	307.082	Cathode removal tool	
	307.083	Maintenance kit	
CABLES AND HOSES			
	307.054-01	Cable, water cooled, negative, 12 ft	987-7-12
	307.055-01	Cable, water cooled, positive, 12 ft	987-8-12
	307.058-01	Hose, gas powder, 12 ft	985-4-12
	307.070-01	Hose, gas, 12 ft	985-2-12
	307.537	Kit fittings SG100 to Metco	

2086 SG-100 PLASMA GUN EXTENSION			
Pos.	FST p/n	Product Description	OEM / Remark
	307.200-01	2086 SG-100 extension, 12"	–
	307.200-02	2086 SG-100 extension, 24"	–
	307.201-01	SG-100 with 12" 2086 extension	–
	307.201-02	SG-100 with 24" 2086 extension	–
1	307.202	Tube clips	2084-95
2	307.223	Screw	–
3	307.203-01	Powder tube assembly, 12"	2084A-83-12
	307.203-02	Powder tube assembly, 24"	2084A-83-24
4	307.048	O-Ring, 006S	2-006S
5	307.204-01	Tube, air cap assembly, 12"	2084A-85-12
	307.204-02	Tube, air cap assembly, 24"	2084A-85-24
6	307.205	Insulator, rear	2084A-70
7	307.206-01	Collar, locking	2084-82
8	307.207	Plate, front	2084-81
9	307.224	Screw	–
10	307.208-01	Tube, outside, 12"	2084A-74-12
	307.208-02	Tube, outside, 24"	2084A-74-24
11	307.209-01	Tube, divider, 12"	2084A-75-12
	307.209-02	Tube, divider, 24"	2084A-75-24
12	307.210	O-Ring, 013S	2-013S
13	307.211-01	Cathode holder extension, 12"	2084A-76-12
	307.211-02	Cathode holder extension, 24"	2084A-76-24
14	307.025	Cathode, sub-sonic	3083-129, for SG-100/2086
15	307.212	O-Ring, 019S	2-019S
16	307.213	Gun housing, middle	2084B-100
17	307.214	Gas distributor	2084B-102
18	307.215	Gas injector	2084B-103
19	307.216	Water divider, outer	2084B-101
20	307.066	O-Ring, 022S	2-022S
21	307.217	O-Ring, 021S	2-021S
22	307.065	O-Ring, 017S	2-017S
23	307.218	Tube divider	2084-77
24	307.219-01	Anode, 45 deg.	2084-F45
	307.219-02	Anode, 60 deg.	2084-F60
25	307.220	Ring, locking, anode	2084-80
OTHERS			
	307.221	O-Ring kit for 2086 plasma gun	–